

Timberaul Windows and Doors



Cedar and Meranti Collection



DECADES OF CRAFTSMANSHIP

Stegbar started making timber windows and doors in 1946 and has since developed a reputation built on quality, innovation and craftsmanship. As Australia's preferred timber window and door range, Timberaul Windows and Doors will elevate your home and provide you with years of outstanding performance. For natural beauty and thermal excellence, raise the bar with Timberaul from Stegbar.

- Two timber species available - Western Red Cedar and Meranti
- Customisable to suit your project requirements
- Can match existing windows for heritage and window replacement
- Finish options include classic clear coating and pre-primed
- U-values as low as 1.5
- Multiple Hardware options and colours
- Bushfire protection up to BAL 40
- Rigorously tested and Australian made
- Sourced from sustainable plantations
- A large range of glass options available, including double glazing and privacy
- Installation service available
- Market leading 10-year warranty

SPECIES OPTIONS



Western Red Cedar



Meranti

Timberaul Aneeta Sashless Window



Cedar and Meranti Collection

SPECIFICATIONS

Product	Aneeta Sashless Window
Product Series	Timberaul
Frame Profile	138mm x 26mm – Meranti 138mm x 38mm – Cedar
Sill Options	138mm or 165mm Cedar, Meranti or Hardwood
Max Frame	3000mm high
Max Sash	3000mm high x 1020mm wide
Glazing	6mm - 16mm
Species Options	Western Red Cedar, Meranti
Finish Options	Classic Pre-primed Raw
Screen Options	External fixed timber or aluminium
Installation	Stegbar installation service or by builder
Warranty	10-year warranty

PERFORMANCE

Wind & Water Performance	
SLS	800Pa
ULS	2000Pa
Water	300Pa
N Rating	N3 Corner/N4 General
Thermal Performance	
Uw	2.2 - 5.0
SHGC	0.22 - 0.66
N4	General

CONFIGURATIONS

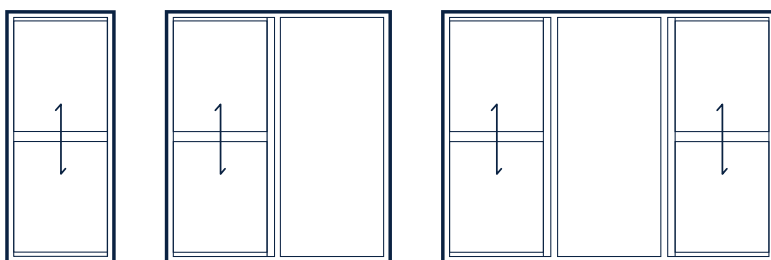

For further custom configurations and design options, please speak to your Stegbar consultant.

Timberaul Awning Window



Cedar and Meranti Collection

SPECIFICATIONS

Product	Awning Window
Product Series	Timberaul
Frame Profile	138mm x 26mm – Meranti 138mm x 38mm – Cedar
Sill Options	138mm or 165mm Cedar, Meranti or Hardwood
Max Frame	2700mm high
Max Sash Options	2400mm high x 800mm wide 800mm high x 2400 wide
Sash Profile	Stiles – 42mm or 66mm Top rail – 42mm or 66mm Bottom rail – 66mm
Sash/Panel Construction	V Groove
Glazing	4mm – 20mm
BAL Rating	BAL 19 Meranti BAL 40 Cedar
Seal Type	Compression
Species Options	Western Red Cedar, Meranti
Finish Options	Classic Pre-primed Raw
Screen Options	Internal fixed timber or aluminium
Hardware Options	Chain Winder - Black, White, Silver, Monument, Brushed Nickel Sash Lock - Black, White, Silver, Monument, Hamersley Brown
Installation	Stegbar installation service or by builder
Warranty	10-year warranty

PERFORMANCE

Acoustic Performance	
RW	30
RW	31
Wind & Water Performance	
SLS	800Pa
ULS	2000Pa
Water	450Pa
N Rating	N3 Corner/N4 General
Thermal Performance	
Uw	1.5 - 4.7
SHGC	0.13 - 0.58

Timberaul Awning Window



Cedar and Meranti Collection

HARDWARE



Chain Winder - Black



Sash Lock - Black

CONFIGURATIONS

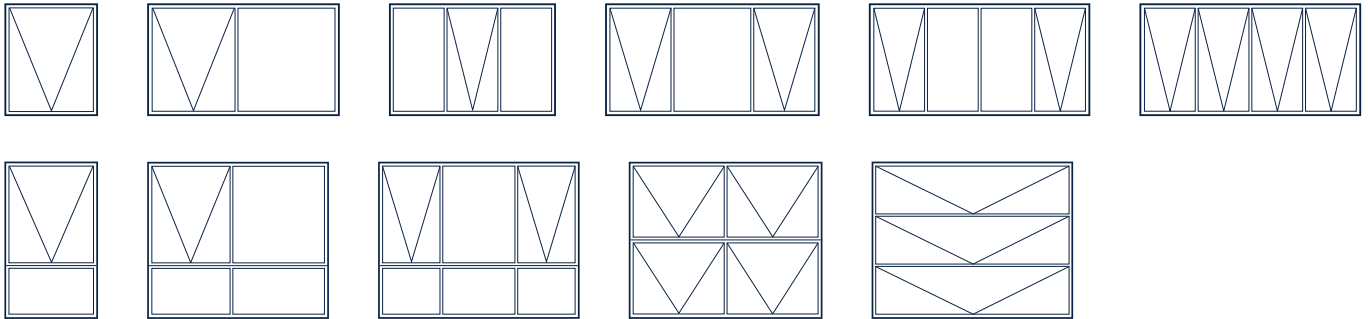

For further custom configurations and design options, please speak to your Stegbar consultant.

Timberaul Bi-fold Window



Cedar and Meranti Collection

SPECIFICATIONS

Product	Bi-fold Window	Bi-fold Window with Screens
Product Series	Timberaul	Timberaul
Frame Profile	138mm x 26mm – Meranti 138mm x 38mm – Cedar	138mm x 38mm – Cedar
Sill Options	138mm or 165mm Hardwood U channel	138mm or 165mm Hardwood No sill
Max Frame	1600mm high	1540mm high x 2500mm wide
Max Sash	1500mm high x 800mm wide	1500mm high x 800mm wide
Sash Profile	Stiles – 66mm or 112mm Top rail – 66mm or 112mm Bottom rail – 66mm or 112mm	Stiles – 66mm Top Rail – 66mm Bottom Rail – 66mm
Sash/Panel Construction	V Groove	V Groove
Glazing	4mm – 20mm	4mm – 20mm
Seal Type	Compression	Compression
Species Options	Western Red Cedar, Meranti	Western Red Cedar
Finish Options	Classic Pre-primed Raw	Classic Pre-primed Raw
Screen Options	N/A	Internal – roll down (Not available for corner configuration)
Hardware Options	Flush mounted drop bolt – White, Black, Satin Chrome	Flush mounted drop bolt – White, Black, Satin Chrome
Installation	Stegbar installation service or by builder	Stegbar installation service or by builder
Warranty	10-year warranty	10-year warranty

PERFORMANCE

Wind & Water Performance	
SLS	600Pa
ULS	1400Pa
Water	150Pa
N Rating	N2 Corner/N3 General
Thermal Performance	
Uw	1.9 - 4.5
SHGC	0.13 - 0.51

Timberaul Bi-fold Window



Cedar and Meranti Collection

HARDWARE



Drop Bolt - Black

CONFIGURATIONS

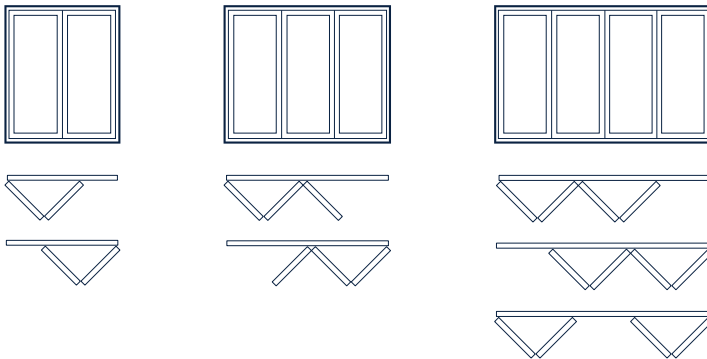

For further custom configurations and design options, please speak to your Stegbar consultant.

SILL OPTIONS

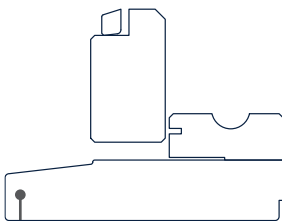

Standard Sill

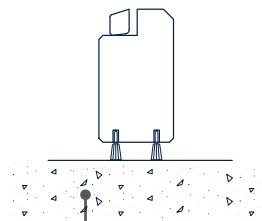

No Sill

Timberaul Breezway Louvre Window



Cedar and Meranti Collection

SPECIFICATIONS

Product	Breezway Louvre Window
Product Series	Timberaul
Frame Profile	138mm x 26mm – Meranti 138mm x 38mm – Cedar
Sill Options	138mm or 165mm Cedar, Meranti or Hardwood
Max Frame	3000mm high
Max Sash	3000mm high x 1020mm wide
Glazing	6mm - 22mm
Species Options	Western Red Cedar, Meranti
Finish Options	Classic Pre-primed Raw
Screen Options	External fixed timber or aluminium
Installation	Stegbar installation service or by builder
Warranty	10-year warranty

PERFORMANCE

Wind & Water Performance	
SLS	800Pa
ULS	2000Pa
Water	300Pa
N Rating	N3 Corner/N4 General
Thermal Performance	
Uw	2.6 - 6.0
SHGC	0.40 - 0.73

CONFIGURATIONS

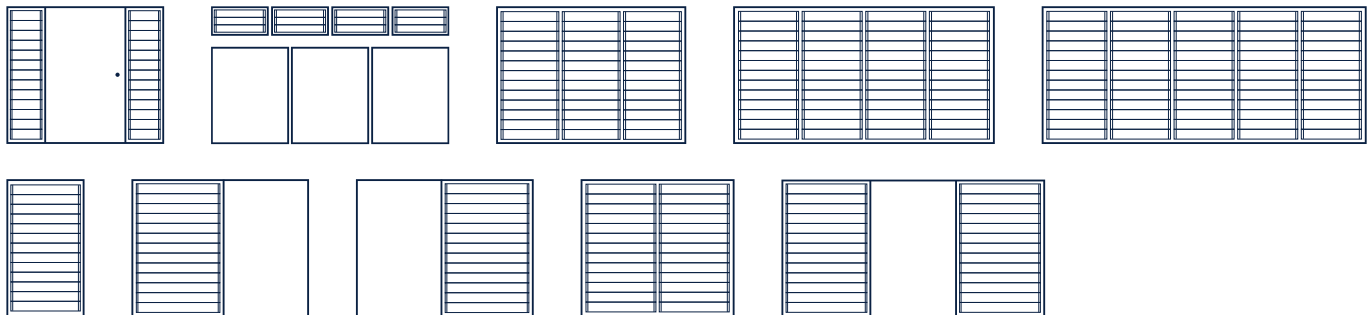

For further custom configurations and design options, please speak to your Stegbar consultant.

Timberaul Casement Window



Cedar and Meranti Collection

SPECIFICATIONS

Product	Casement Window
Product Series	Timberaul
Frame Profile	138mm x 26mm – Meranti 138mm x 38mm – Cedar
Sill Options	138mm or 165mm Cedar, Meranti or Hardwood
Max Frame	2700mm high
Max Sash Options	2400mm high x 550mm wide 1600mm high x 850mm wide
Sash Profile	Stiles – 66mm Top Rail – 66mm Bottom Rail – 66mm
Sash/Panel Construction	V Groove
Glazing	4mm – 20mm
BAL Rating	BAL 19 Meranti BAL 40 Cedar
Seal Type	Compression
Species Options	Western Red Cedar, Meranti
Finish Options	Classic Pre-primed Raw
Screen Options	Internal fixed timber or aluminium
Hardware Options	Secura Winder - Black, White, Silver, Hamersley Brown, Satin Chrome Cam Lock - Black, White, Satin Nickel, Hamersley Brown Sash Lock - Black, White, Silver, Monument, Hamersley Brown
Installation	Stegbar installation service or by builder
Warranty	10-year warranty

PERFORMANCE

Acoustic Performance	
RW	30
RW	31
Wind & Water Performance	
SLS	800Pa
ULS	2000Pa
Water	200Pa
N Rating	N3 Corner/N4 General
Thermal Performance	
Uw	1.5 - 4.4
SHGC	0.13 - 0.52

Timberaul Casement Window



Cedar and Meranti Collection

HARDWARE



Sash Lock - Black



Cam Lock - Black

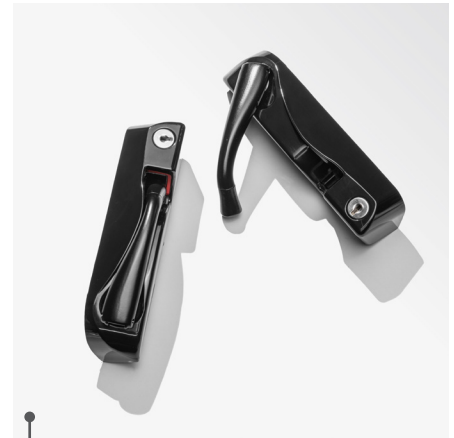

Secura Winder - Black

CONFIGURATIONS

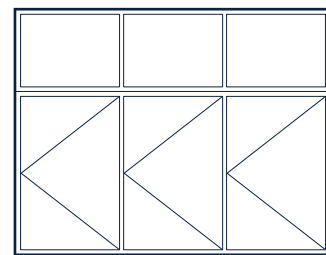
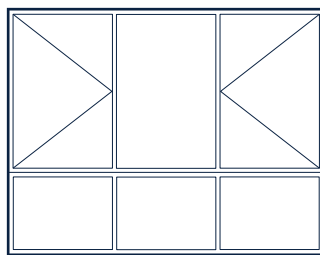
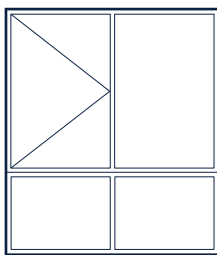
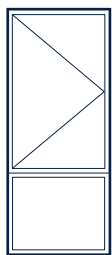
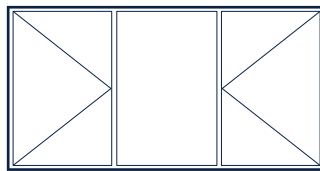
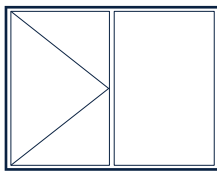

For further custom configurations and design options, please speak to your Stegbar consultant.

Timberaul Double Hung Window

Cedar and Meranti Collection

SPECIFICATIONS

Product	Double Hung Window
Product Series	Timberaul
Frame Profile	138mm x 26mm – Meranti 138mm x 38mm – Cedar
Sill Options	138mm or 165mm Cedar, Meranti or Hardwood
Max Frame	2400mm high
Max Sash	1210mm high x 1210mm wide
Sash Profile	Stiles – 66mm Top rail – 66mm Bottom rail – 66mm
Sash/Panel Construction	V Groove
Glazing	4mm – 20mm
BAL Rating	Meranti & Cedar BAL 19 (Deemed to satisfy BAL 19)
Seal Type	Finseal
Species Options	Western Red Cedar, Meranti
Finish Options	Classic Pre-primed Raw
Screen Options	Internal fixed timber or aluminium
Hardware Options	Double Hung lock – White, Black, Satin Nickel, Hamersley Brown
Installation	Stegbar installation service or by builder
Warranty	10-year warranty

PERFORMANCE

Acoustic Performance	
RW	26
Wind & Water Performance	
SLS	800Pa
ULS	2000Pa
Water	200Pa
N Rating	N3 Corner/N4 General
Thermal Performance	
Uw	1.5 - 4.7
SHGC	0.15 - 0.61

Timberaul Double Hung Window



Cedar and Meranti Collection

HARDWARE



Double Hung Lock - Black

CONFIGURATIONS

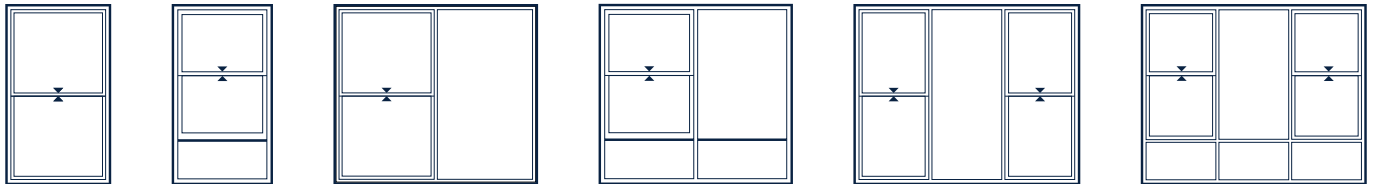

For further custom configurations and design options, please speak to your Stegbar consultant.

SASH HORN OPTIONS

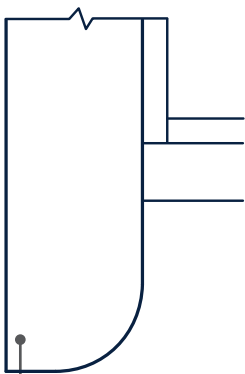

Sash Horn 1

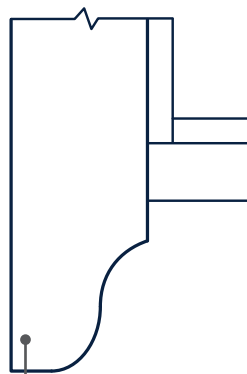

Sash Horn 2

Timberaul Fixed Window



Cedar and Meranti Collection

SPECIFICATIONS

Product	Fixed Window
Product Series	Timberaul
Frame Profile	138mm x 26mm – Meranti 138mm x 38mm – Cedar
Sill Options	138mm or 165mm Cedar, Meranti or Hardwood
Max Frame	3200mm high
Max Sash Options	Single lite 6m2 per lite Multi lite 4m2 per lite
Sash/Panel Construction	V Groove
Glazing	4mm – 20mm
BAL Rating	BAL 19 Meranti BAL 40 Cedar
Species Options	Western Red Cedar, Meranti
Finish Options	Classic Pre-primed Raw
Installation	Stegbar installation service or by builder
Warranty	10-year warranty

PERFORMANCE

Wind & Water Performance	
SLS	800Pa
ULS	2000Pa
Water	300Pa
N Rating	N3 Corner/N4 General
Thermal Performance	
Uw	1.7 - 5.2
SHGC	0.19 - 0.74

CONFIGURATIONS

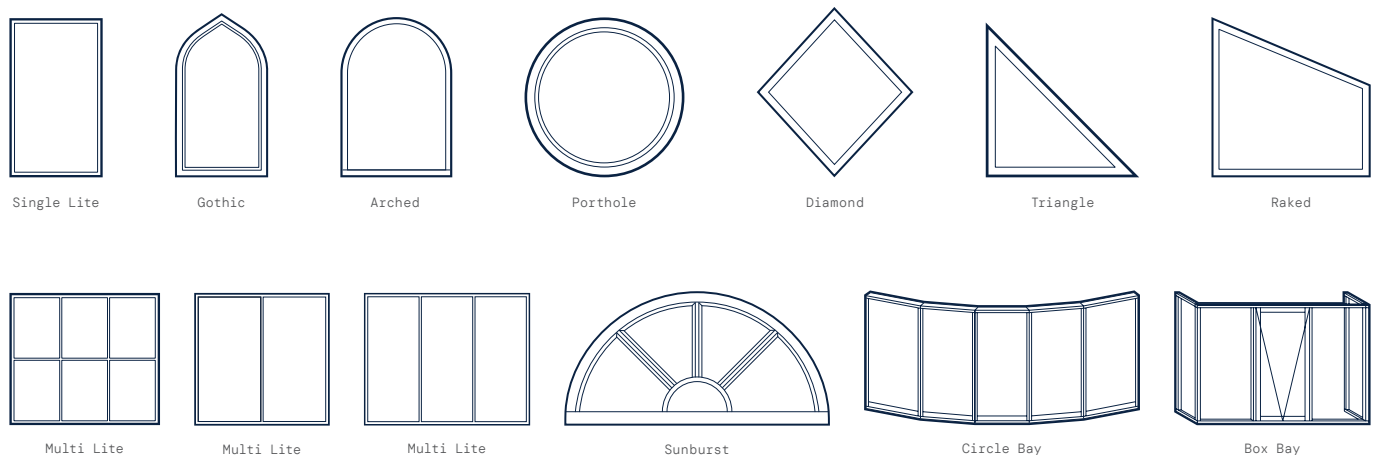

Timberaul Sliding Window



Cedar and Meranti Collection

SPECIFICATIONS

Product	Sliding Window
Product Series	Timberaul
Frame Profile	138mm x 26mm – Meranti 138mm x 38mm – Cedar
Sill Options	138mm 165mm (Servery only)
Max Frame	2700mm high
Max Sash	1600mm high x 1500mm wide
Sash Profile	Stiles – 66mm Top rail – 66mm Bottom rail – 66mm
Sash/Panel Construction	V Groove
Glazing	4mm – 20mm
BAL Rating	Deemed to satisfy BAL 19
Seal Type	Mohair
Species Options	Western Red Cedar, Meranti
Finish Options	Classic Pre-primed Raw
Screen Options	External timber or aluminium screens Sliding timber or aluminium (Servery)
Hardware Options	Sliding window lock – White, Black, Satin Nickel, Hamersley Brown
Installation	Stegbar installation service or by builder
Warranty	10-year warranty

PERFORMANCE

Wind & Water Performance	
SLS	800Pa
ULS	2000Pa
Water	200Pa
N Rating	N3 Corner/N4 General
Thermal Performance	
Uw	1.6 - 4.7
SHGC	0.14 - 0.56

Timberaul Sliding Window

Cedar and Meranti Collection



HARDWARE



Sliding Window Lock - Black

CONFIGURATIONS

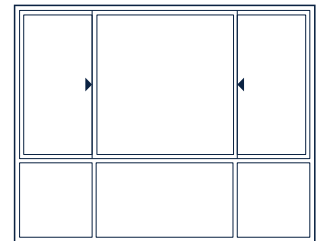
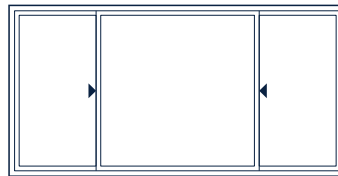
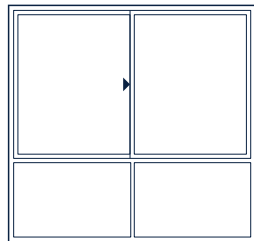
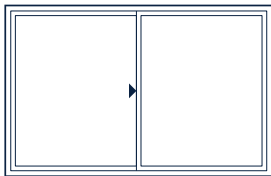

For further custom configurations and design options, please speak to your Stegbar consultant.

Timberaul Bi-fold Door



Cedar and Meranti Collection

SPECIFICATIONS

Product	Bi-fold Door
Product Series	Timberaul
Frame Profile	138mm x 26mm – Meranti 138mm x 38mm – Cedar
Sill Options	138mm or 165mm Hardwood U channel
Max Frame	2700mm high 2400mm (corner bi-fold)
Max Sash Options	2700mm high x 890mm wide 2400mm high x 1000mm wide
Sash Profile	Stiles – 112mm Top rail – 112mm Bottom rail – 138mm
Sash/Panel Construction	V Groove
Glazing	4mm – 20mm
BAL Rating	Meranti BAL 19 Cedar BAL 40 (Open out with sill only)
Seal Type	Compression
Species Options	Western Red Cedar, Meranti
Finish Options	Classic Pre-primed Raw
Hardware Options	Palladium - Satin Chrome, Black Slit - Stainless Steel Drop bolts - Satin Chrome, Gold
Installation	Stegbar installation service or by builder
Warranty	10-year warranty

PERFORMANCE

Wind & Water Performance	
SLS	600Pa
ULS	1400Pa
Water	300Pa
N Rating	N2 Corner/N3 General
Thermal Performance	
Uw	1.6 - 4.1
SHGC	0.13 - 0.52

Timberaul Bi-fold Door



Cedar and Meranti Collection

HARDWARE



Flush Bolt - Satin Chrome



Slit - Stainless Steel



Palladium - Black

CONFIGURATIONS

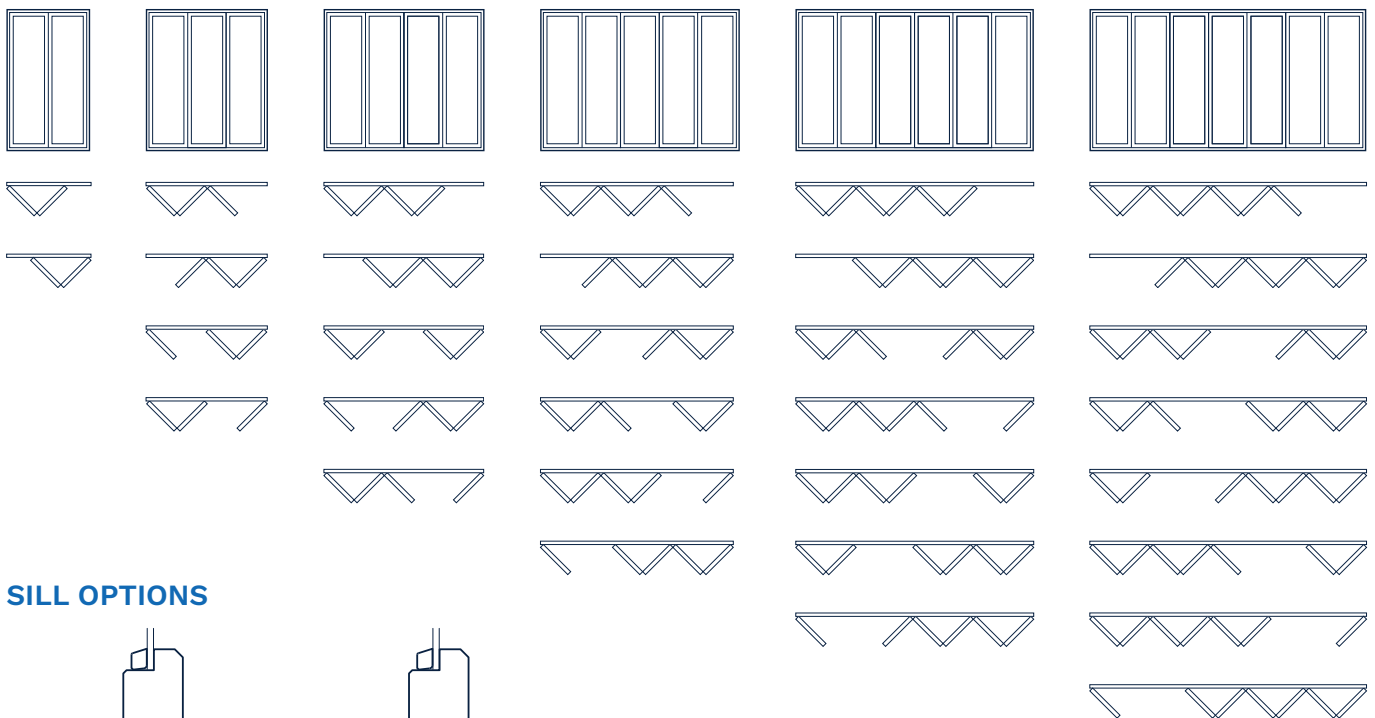

SILL OPTIONS

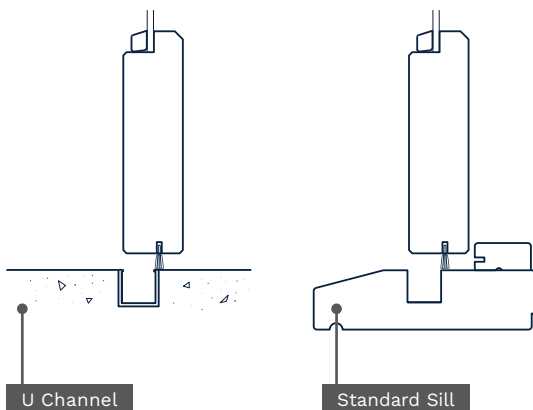

For further custom configurations and design options, please speak to your Stegbar consultant.

Timberaul Entry frame



Cedar and Meranti Collection

SPECIFICATIONS

Product	Entry frame
Product Series	Timberaul
Frame Profile	138mm x 26mm – Meranti 138mm x 38mm – Cedar
Sill Options	138mm or 165mm Cedar, Meranti or Hardwood
Max Frame	2700mm high
Sash/Panel Construction	V Groove
Glazing	4mm – 20mm
BAL Rating	Meranti BAL 19
Species Options	Western Red Cedar, Meranti
Screen options	Timber or aluminium
Finish Options	Classic Pre-primed Raw
Installation	Stegbar installation service or by builder
Warranty	10-year warranty

CONFIGURATIONS

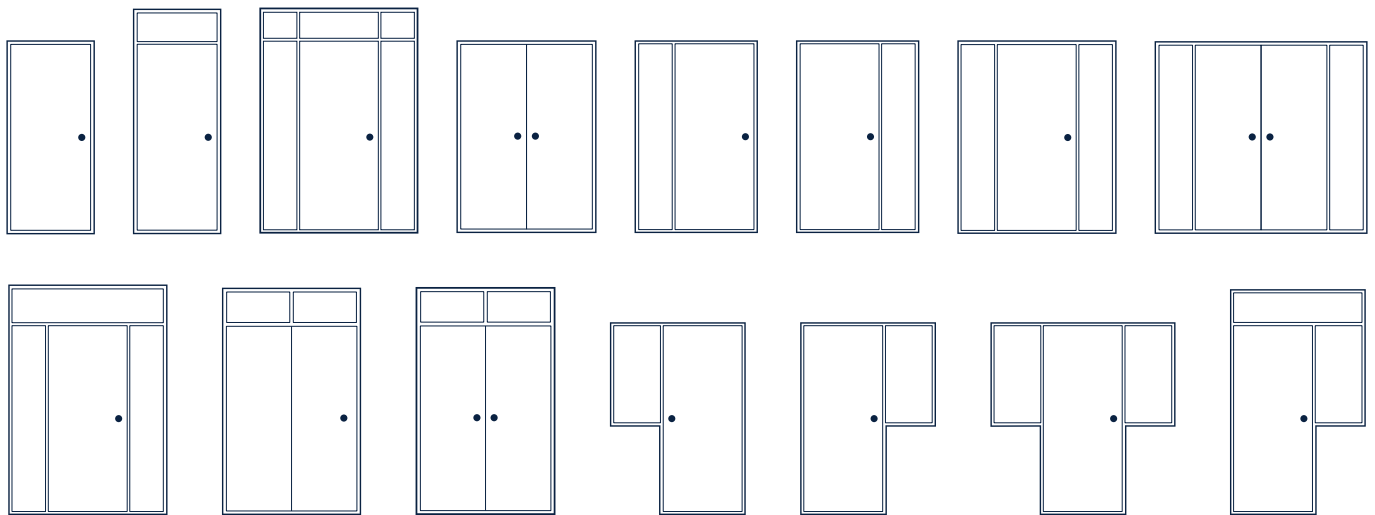

For further custom configurations and design options, please speak to your Stegbar consultant.

Timberaul Hinged Door



Cedar and Meranti Collection

SPECIFICATIONS

Product	Hinged Door
Product Series	Timberaul
Max Frame	2700mm high
Max Sash	2700mm high x 1020mm wide
Sash Profile	Stiles – 112mm Top rail – 112mm Bottom rail – 138mm
Sash/Panel Construction	V Groove
Glazing	4mm – 20mm
BAL Rating	BAL 19 Meranti BAL 40 Cedar
Species Options	Western Red Cedar, Meranti
Finish Options	Classic Pre-primed Raw
Hardware Options	Palladium - Satin Chrome, Black Slit - Stainless Steel
Installation	Stegbar installation service or by builder
Warranty	10-year warranty

PERFORMANCE

Wind & Water Performance	
SLS	800Pa
ULS	2000Pa
Water	200Pa
N Rating	N2 Corner/N3 General
Thermal Performance	
Uw	1.5 - 4.2
SHGC	0.13 - 0.55

Timberaul Hinged Door

Cedar and Meranti Collection



HARDWARE



Slit - Stainless Steel



Palladium - Black

CONFIGURATIONS



Fitzroy

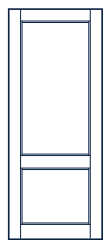

Douglas



Rosemont

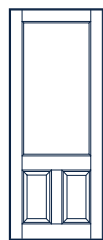

Dalton



Terrace

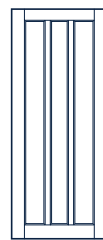

Classic



Linear

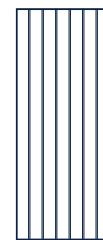

Capital



Baron

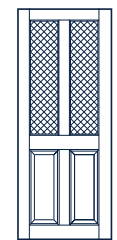

Balmoral

CLOSING OPTIONS

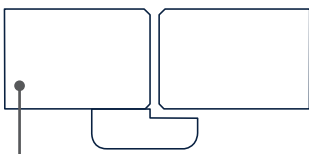

Mushroom Stop

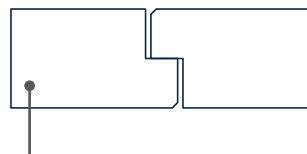

Rebate

SILL OPTIONS

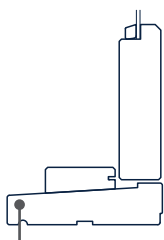

Open In

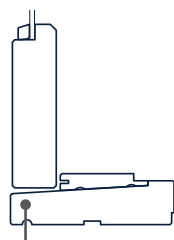

Open Out

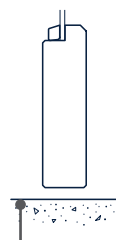

No Sill

Timberaul Sliding Door



Cedar and Meranti Collection

SPECIFICATIONS

Product	Bi-fold Door
Product Series	Timberaul
Frame Profile	138mm x 26mm – Meranti 138mm x 38mm – Cedar
Sill Options	165mm
Max Frame	2700mm high
Max Sash Options	2700mm high x 1400mm wide 2400mm high x 1800mm wide
Sash Profile	Stiles – 112mm Top rail – 112mm or 138mm Bottom rail – 112mm or 138mm or 165mm
Sash/Panel Construction	V Groove
Glazing	4mm – 20mm
Seal Type	Mohair
Species Options	Western Red Cedar, Meranti
Finish Options	Classic Pre-primed Raw
Screen Options	External sliding timber or aluminium
Hardware Options	Bisarra - White, Black, Silver, Hamersley brown Timbarra - White, Black, Silver, Satin Chrome Onyx slimline - White, Black, Silver, Satin Chrome
Installation	Stegbar installation service or by builder
Warranty	10-year warranty

PERFORMANCE

Wind & Water Performance	
SLS	800Pa
ULS	2000Pa
Water	200Pa
N Rating	N3 Corner/N4 General
Thermal Performance	
Uw	1.6 - 4.5
SHGC	0.14 - 0.60

Timberaul Sliding Door

Cedar and Meranti Collection



HARDWARE



Timbarra - Black



Bisarra - Black



Onyx - Black

CONFIGURATIONS

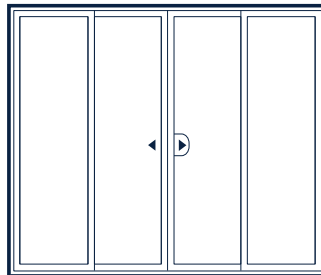
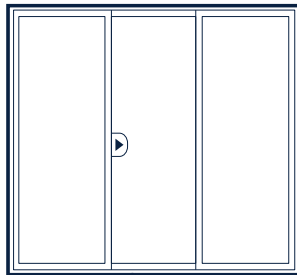
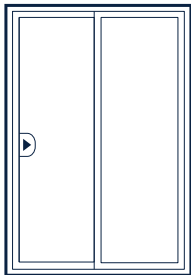

For further custom configurations and design options, please speak to your Stegbar consultant.

Timberaul Stacker Door

STEGBAR

Cedar and Meranti Collection

SPECIFICATIONS

Product	Bi-fold Door
Product Series	Timberaul
Frame Profile	138mm x 26mm – Meranti 138mm x 38mm – Cedar
Sill Options	250mm
Max Frame	2700mm high
Max Sash Options	2700mm high x 1400mm wide 2400mm high x 1800mm wide
Sash Profile	Stiles – 112mm Top rail – 112mm or 138mm Bottom rail – 112mm or 138mm or 165mm
Sash/Panel Construction	V Groove
Glazing	4mm – 20mm
Seal Type	Mohair
Species Options	Western Red Cedar, Meranti
Finish Options	Classic Pre-primed Raw
Screen Options	External sliding timber or aluminium
Hardware Options	Bisarra - White, Black, Silver, Hamersley brown Timbarra - White, Black, Silver, Satin Chrome Onyx slimline - White, Black, Silver, Satin Chrome
Installation	Stegbar installation service or by builder
Warranty	10-year warranty

PERFORMANCE

Wind & Water Performance	
SLS	800Pa
ULS	2000Pa
Water	200Pa
N Rating	N3 Corner/N4 General
Thermal Performance	
Uw	1.6 - 4.5
SHGC	0.14 - 0.60

Timberaul Stacker Door



Cedar and Meranti Collection

HARDWARE



Timbarra - Black



Bisarra - Black



Onyx - Black

CONFIGURATIONS

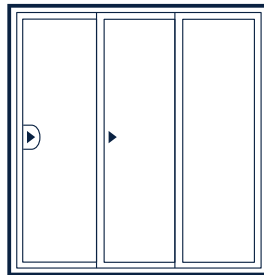
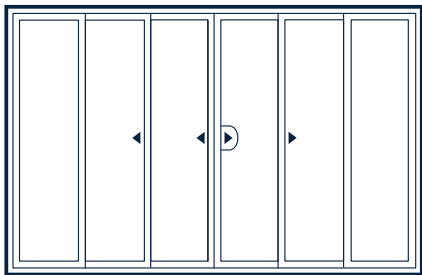

For further custom configurations and design options, please speak to your Stegbar consultant.

Timberaul Glazing Bars for Windows and Doors



Cedar and Meranti Collection

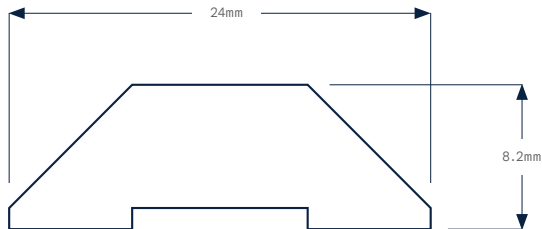

ELEVATE YOUR TIMBERAUL WINDOWS & DOORS

Glazing Bars help to create a statement or can be used to complement your style. Whether your preference is Hamptons, French Provincial or Industrial styling; glazing bars will bring your design vision to life. Timberaul have many glazing bar patterns and layout options available and if you don't find something that suits your look, or you want something unique, simply talk to your Stegbar Consultant to create your own.

HORIZONTAL GLAZING BAR - WINDOWS

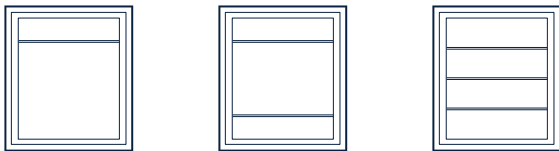

HORIZONTAL GLAZING BAR - DOORS

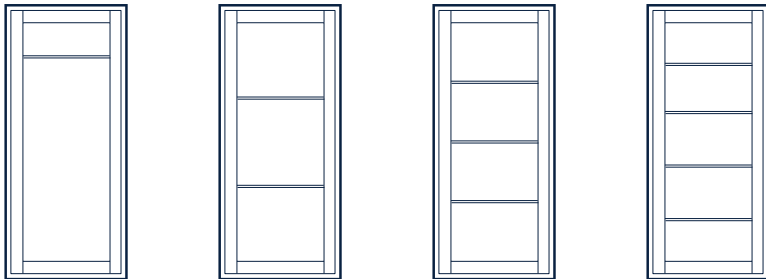

COLONIAL GLAZING BAR - WINDOWS

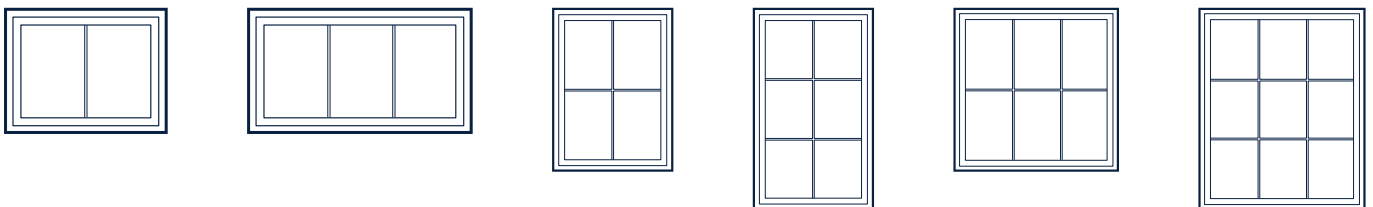

COLONIAL GLAZING BAR - DOORS

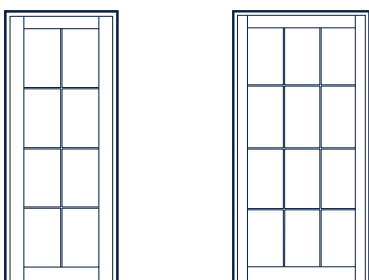

Timberaul Glazing Bars for Windows and Doors



Cedar and Meranti Collection

FEDERATION GLAZING BAR - WINDOWS

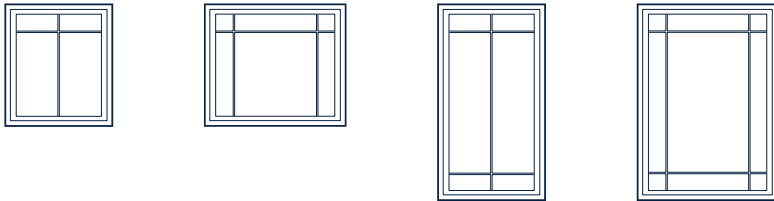

FEDERATION GLAZING BAR - DOORS

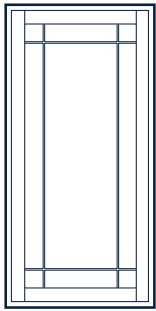

EDWARDIAN GLAZING BAR - WINDOWS

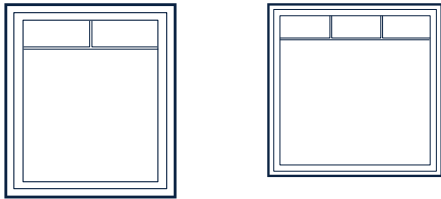

EDWARDIAN GLAZING BAR - DOORS

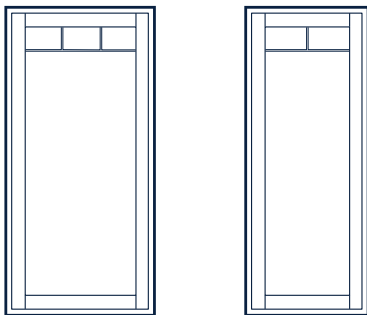

For further custom configurations and design options, please speak to your Stegbar consultant.



Whilst the utmost care is taken to ensure the accuracy of the information contained herein, it is provided in the understanding that the company shall under no circumstances be liable for any injuries, expenses or other losses which may in any way be attributable to the use or adoption of such data and/or design details. Stegbar reserves the right to alter or amend without prior notice data and design details specified herein. stegbar.com.au STENAT0041/0824